

dji MIC 3

User Manual

v1.0 2025.8





This document is copyrighted by DJI with all rights reserved. Unless otherwise authorized by DJI, you are not eligible to use or allow others to use the document or any part of the document by reproducing, transferring or selling the document. Only refer to this document and the content thereof as instructions to operate DJI products. The document should not be used for other purposes.

In the event of divergence among different versions, the English version shall prevail.

Searching for Keywords

Search for keywords such as “battery” and “install” to find a topic. If you are using Adobe Acrobat Reader to read this document, press Ctrl+F on Windows or Command+F on Mac to begin a search.

Navigating to a Topic

View a complete list of topics in the table of contents. Click on a topic to navigate to that section.

Printing this Document

This document supports high resolution printing.

Using this Manual

Legend

 Important

 Hints and Tips

 Reference

Read Before Use

DJI™ provides you with tutorial videos and the following documents:

1. *Safety Guidelines*
2. *Quick Start Guide*
3. *User Manual*

It is recommended to watch all the tutorial videos and read the *Safety Guidelines* before using for the first time. Make sure to review the *Quick Start Guide* before using for the first time and refer to this *User Manual* for more information.

Contents



Using this Manual	3
Legend	3
Read Before Use	3
1 Product Profile	5
1.1 Transmitter (TX)	5
1.2 Receiver (RX)	6
1.3 Charging Case	7
2 Using the Product	9
2.1 Touchscreen	9
Home Screen	9
Swipe Down - Control Menu	10
Swipe Up - Transmitter Control Interface	14
2.2 Quick Actions with the Dial	15
2.3 Installing the Windscreen	16
2.4 Wearing the Transmitter	16
2.5 Linking the Transmitter and Receiver	17
Basic Linking Operation	17
Linking via the Charging Case	17
Linking Manually	17
Group Linking	18
2.6 Using with a Phone	19
2.7 Using with a Camera	20
2.8 Using with a Computer	21
2.9 Transmitter Directly Connected to DJI Filming Devices	22
2.10 Charging	23
2.11 Storage	24
3 Firmware Update and Parameter Adjustment	25
3.1 Connecting to the DJI Mimo App	25
Connecting via the Adapter	25
Connecting via Wi-Fi	25
3.2 Adjusting Parameters	26
3.3 Updating Firmware	26
4 Appendix	27
4.1 Specifications	27
4.2 Aftersales Information	27

1 Product Profile

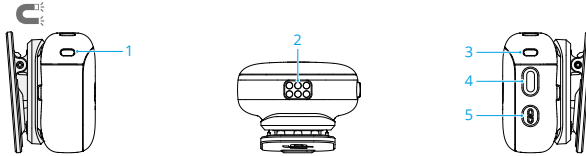
1.1 Transmitter (TX)



1. Recording Status LED



 —	Solid red	Transmitter recording independently ^[1]
	Blinks red slowly	Transmitter muted

[1] Audio is saved to the transmitter's built-in storage (hereinafter referred to as "internal recording").







2. Charging Contact

3. System Status LED



Battery Level





 —	Solid red	≤ 10%
 —	Solid green/blue ^[1]	> 10%

Linking/Connection status

 —	Solid green	Linked with the receiver
	Blinks green slowly	No receiver linked
 —	Solid blue	Connected to a Bluetooth device
	Blinks blue slowly	No Bluetooth device connected
 —	Solid cyan	Connected to the DJI Mimo app
	Blinks blue and green alternately	Linking/Connecting

Battery Level During Charging^[1]

	Blinks green/blue slowly	0-25%
 × 2	Blinks green/blue twice	26-50%

 × 3	Blinks green/blue three times	51-75%
 × 4	Blinks green/blue four times	76-100%
	Off	Charging completed ^[2]
Other Status		
 —	Solid yellow	Noise cancellation enabled
	Blinks red and green alternately	Firmware updating

[1] The color of the light depends on the wireless working mode. Take the green light as an example.

[2] When charging is complete, the LED stays on for one minute and then goes off.

4. Power Button

Press and hold for two seconds to power on or off.

Press to start or stop internal recording.

Press twice to enable or disable noise cancellation.

5. Linking Button

Press and hold for two seconds to start linking.

Press twice to switch wireless working modes.

After connecting the microphone to the DJI filming equipment, press to start or stop recording videos.

1.2 Receiver (RX)

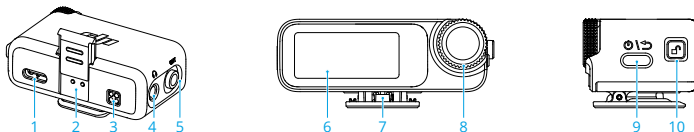

1. USB-C Port

2. Expansion Port

Used for connecting to the phone adapter.

3. Charging Contacts

4. Monitor Port

Plug in 3.5 mm headset to monitor transmitter audio quality.

5. Output port

For audio output to a camera.

6. Touchscreen

7. Back Clip

8. Dial

For convenient device control and parameter adjustment. Refer to [Quick Actions with the Dial](#) for details.

9. Power Button

Press and hold to power on or off.

When the receiver screen is not on the home screen, press the to return to the previous page.

10. Release Button

Press and hold to remove the sliding cover or adapter from the expansion port.

1.3 Charging Case

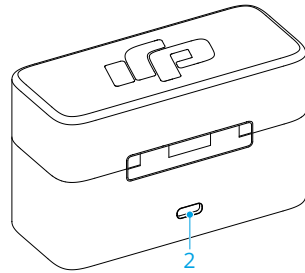
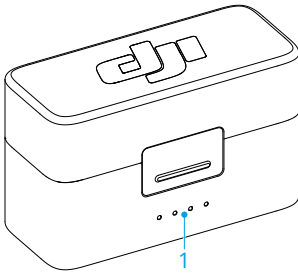

1. Battery Level LEDs

● LED is on











⦿ LED is blinking

○ LED is off

Battery Level During Charging (LEDs blink in sequence)



76-99%

	51-75%
	26-50%
	≤ 25%
	Fully charged
Battery Level	
	76-100%
	51-75%
	26-50%
	10-25%
	<10%
Firmware update (LEDs flash simultaneously)	
	Firmware updating

2. USB-C Port

For charging or copying internal recordings.

-
-  Fully charge the battery at least once every three months to maintain battery health. If the battery is not used for an extended period, battery performance may be affected or may even cause permanent battery damage.
-

2 Using the Product

2.1 Touchscreen

For first-time use, language and time settings are required. It is recommended to scan the QR code on the screen to download the DJI Mimo app for a better wireless experience.

Home Screen

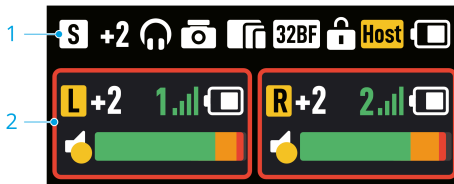

The receiver's touchscreen display may vary when linked to different devices.

The following shows a reference display with two transmitters connected.









1. Receiver Status Bar

S	Current channel mode
+2	Receiver gain
	Headset connected
	Screen locked
	Camera adapter connected
	Phone/computer connected
32BF	32-bit float recording enabled
ATC	Timecode is enabled with output type set to A-OUT When the output type is L-OUT, LTC is displayed; when set to L-IN or N/A, TC is displayed.
Host	Receiver has joined a multi-device group and is the main receiver

	Receiver has joined a multi-device group and is the secondary receiver
	Receiver battery level

2. Transmitter Status Bar

	L/R channel Displays CH1/CH2/CH3/CH4 in quadraphonic mode
	Transmitter gain
	Signal strength between the transmitter and the receiver
	Transmitter battery level
	The framed transmitter is recording independently.
	Noise cancellation enabled

Swipe Down - Control Menu



In the control menu, you can link devices, connect the receiver to the DJI Mimo app, and set up timecode. Tap **Receiver Settings** or **Transmitter Settings** to configure more parameters.

Below are descriptions of certain features that may need further explanation.

Timecode

Timecode is a time marker used to synchronize audio and video.

Supported timecode modes

- **Master Run:** The main RX timecode is set to Master Run by default, managing the generation and synchronization of timecode within the group and with external devices.
- **Auto Jam:** The secondary RX timecode defaults to Auto Jam, periodically syncing by receiving the timecode and frame linking rate from the main RX and aligning with external devices.

Common video frame rates are supported, with 29.97 fps set as the default. Ensure all recording devices maintain identical frame rates during recording.

Timecode output type

- N/A: The receiver runs the timecode internally but does not output it externally.
- L-IN: Used to synchronize timecode from an external timecode generator to the receiver.



- When the receiver receives timecode from an external device, EXT is displayed in the upper right corner of the screen.
- Tap **SYNC** to synchronize the timecode to other devices. Tap **RESET** to reset the timecode.

- L-OUT: The receiver outputs timecode externally in Linear Timecode(LTC) format.
- A-OUT: The receiver outputs timecode externally in Audio Timecode(Audio-TC/ATC) format.

For detailed instruction, click the link or scan the QR code to view the tutorial video DJI Mic 3 | Timecode.



<https://www.dji.com/mic-3/video>

Connect to App

Tap to enter app connection mode.

For detailed instruction, click the link or scan the QR code to view the tutorial video DJI Mic 3 | Parameter Adjustment and Firmware Update.



<https://www.dji.com/mic-3/video>

Receiver (RX) Settings

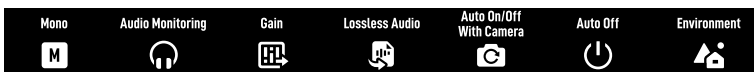

- **Mono**

Tap to switch to stereo or quadraphonic.

Quadraphonic mode allows four transmitters to operate simultaneously, with each assigned to a dedicated audio track for streamlined post-production editing.



- Quadraphonic mode is only compatible with certain PC software and DJI Mic Series Camera Adapter. For details, refer to the compatibility list on the official website.
 - DJI Mic Series Camera Adapter is only compatible with Sony cameras that have an MI hot shoe.
-

- **Audio Monitoring**

Tap to select the monitor source and adjust the volume.

- **Gain**

Tap to open the gain slider and move the slider to adjust the receiver output gain. If the sound is overexposed, turn down the receiver gain first.

- **Lossless Audio**

When lossless audio mode is enabled, the transmitter sends 48 kHz 24-bit uncompressed audio to the receiver, ensuring higher audio quality.

- **Auto On/Off With Camera**

When enabled, the receiver will automatically power on and off with the camera when connected to the camera via the 3.5 mm audio cable or camera adapter.

- **Auto Off**

The receiver will automatically power off when the receiver is not linked to a transmitter within 15 minutes after powering on.

- **Environment**

Both modes support automatic frequency hopping between 2.4 GHz and 5 GHz bands. The difference lies in the operating frequency covered by the two modes in different environments.

The Indoors mode covers a wider frequency range and offers stronger anti-interference performance. However, due to the laws and regulations in some countries or regions, certain 5 GHz frequency bands can only be used indoors. Select the appropriate mode based on your local laws and regulations, as well as your actual indoor or outdoor environment.

Transmitter (TX) Settings

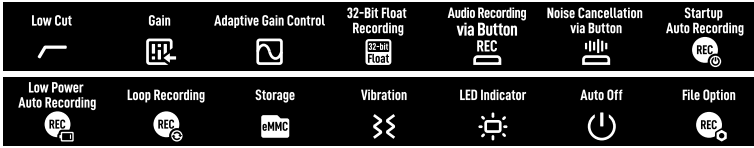

- **Low Cut**

When enabled, transmitter will cut off frequencies that are 100 Hz or below, thus reducing low-frequency noise and making for cleaner recordings.

- **Gain**

Slide to adjust the transmitter input gain according to the real-time volume.

Reduce the gain when the level bar turns red to prevent audio distortion or clipping.

- **Adaptive Gain Control**

Automatic Mode: Ideal for environments with dramatic volume fluctuations. It smoothly handles volume fluctuations and suppresses sudden spikes, ensuring balanced and consistent audio output.

Dynamic Mode: It automatically adjusts the audio output's dynamic range based on changes in input levels, compensating for input that is too low or too high by increasing or decreasing the gain as needed, ideal for quiet indoor settings like studios.

- **32-Bit Float Recording**

When enabled, the transmitter can independently record audio files in 32-bit float, which offers a wider dynamic range for audio post-editing.



Note that the recording time of the transmitter will be shorter when 32-bit float recording is enabled.

- **Audio Recording via Button**

When enabled, pressing the transmitter power button will start or stop internal recording.

- **Noise Cancellation via Button**

When enabled, you can press the transmitter power button twice to enable or disable noise cancellation.

- **Startup Auto Recording**

When enabled, the transmitter automatically starts internal recording upon powering on.

- **Low Power Auto Recording**

When enabled, the transmitter automatically starts internal recording when the connected receiver or device/camera is low on battery.

- **Loop Recording**

When enabled, the system automatically splits recorded files at intervals during internal recording and overwrites existing files when storage is full.

- **Auto Off**

When enabled, the transmitter, when not connected to any device and without internal recording activated, automatically shuts down after 15 minutes of no use.

- **File Option**

Set the file type to Dual-File Internal Recording to retain the original audio file while integrating the enabled audio algorithms, simplifying post-production use without the need for additional processing.

Swipe Up - Transmitter Control Interface

Multi-Transmitter Control

If the receiver has joined a group as the main receiver, swipe up on the home screen to simultaneously control all transmitters in the group and start internal recording or noise cancellation.



Single Transmitter Control

Tap the transmitter status bar to access the dedicated control interface for that transmitter, enabling functions such as internal recording and muting.

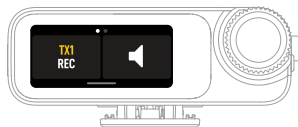

2.2 Quick Actions with the Dial

When the receiver is powered on, press and hold the dial for two seconds to lock or unlock the screen.

When on the Home Screen

Press the dial twice to enter the Control Menu.

Press the dial to trigger area selection.

- 💡 • If no operation is performed within five seconds, the dashed box will disappear.
- Press the receiver power button or touch the screen to exit the dial dashed box selection.

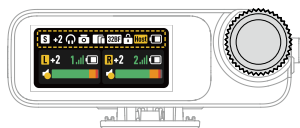

In this interaction mode, rotate the dial to switch between areas, then press the dial to confirm.

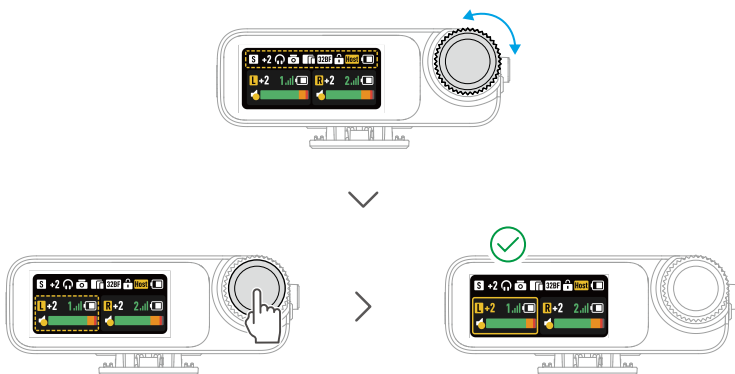

Once the receiver or transmitter status bar is selected, rotating the dial to adjust the gain.

When the dashed box appears on the receiver status bar, press the dial twice to enter multi-transmitter control interface.



When the dashed box stays on the transmitter status bar, press the dial twice to enter single-transmitter control interface.



2.3 Installing the Windscreen

In outdoor or windy environments, use the windscreen to reduce wind noise and improve audio quality.

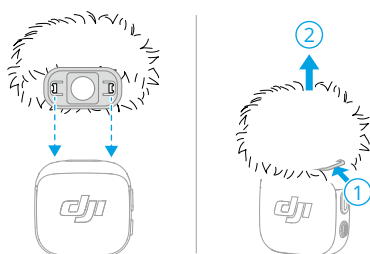

2.4 Wearing the Transmitter

The transmitter can be attached to clothing using the clip and magnet.

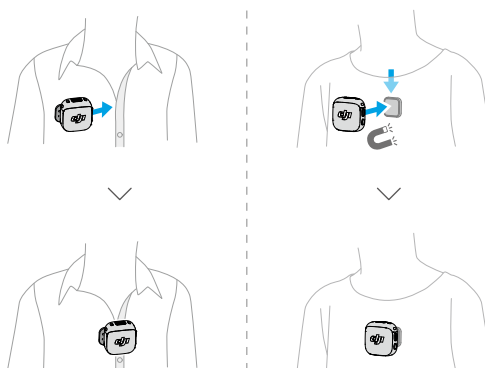

-
- 💡 The magnetic clip features a detachable, rotating design, allowing the transmitter to face the sound source directly when clipped on the side or inverted, resulting in improved audio quality.
-

2.5 Linking the Transmitter and Receiver

The transmitter and receiver in the combos are linked by default. Follow the steps below to link the transmitter and receiver if they become unlinked.

Basic Linking Operation

Linking via the Charging Case

Place the transmitters and the receiver in the charging case to link them automatically.

-
- 💡 If the system status LED of the transmitter is blue, press the linking button twice to change it to green before placing the transmitter in the charging case.
-

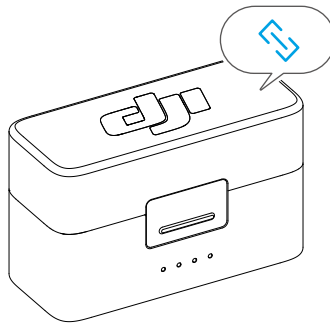

Linking Manually

1. Press and hold the linking button on the transmitter for two seconds until the system status LED blinks blue and green alternately.
2. Swipe down on the receiver screen and tap **Device Linking > +TX > TX1/TX2/TX3/TX4**. The transmitter is linked with the receiver when the system status LED is solid green. Users can view the status of the transmitter on the receiver interface.

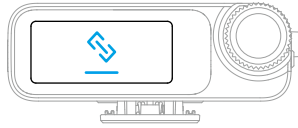

Group Linking

After completing basic linking (1 transmitter with 1 receiver or 2 transmitters with 1 receiver), additional transmitters or receivers can be added, with a maximum of four transmitters and eight receivers supported.

Add More Transmitters into the Group

- Method 1: Linking via the Charging Case
Remove the linked transmitters while keeping the receiver in the charging case. Then, place additional transmitters in it for automatic linking.
- Method 2: Linking Manually
Refer to [“Linking Manually”](#), and follow the same operation to add more transmitters into the group.

Add More Receivers into the Group

1. Swipe down on the receiver screen, tap **Device Linking** > **+RX**. The receiver then becomes the main receiver and is ready to link.
2. On the screen of the new receiver to be added to the group, tap **Device Linking** > **+Group**, verify the code, and tap **Confirm** to complete the process.

Device Management

Tap **Device Management** in the control menu to view the serial numbers, battery levels, or delete devices for all transmitters and receivers in the current group.

For detailed instruction, click the link or scan the QR code to view the tutorial video [DJI Mic 3 | Group Linking](#).



<https://www.dji.com/mic-3/video>

2.6 Using with a Phone

Mounting the Receiver to Your Phone via Adapter

Mount the receiver to your phone using the adapter, then clip or magnetically attach the transmitter to the clothing. The phone can now capture audio through the transmitter.

- 💡 • Press the linking button on the transmitter to start and stop recording. (For apps that use volume buttons as shutter controls only)
- For extended filming or live streaming, it is recommended to use the adapter to attach the receiver to the phone. After installation, when using the charging cable to charge the receiver, the phone can be charged simultaneously.
- The Lightning adapter is sold separately.

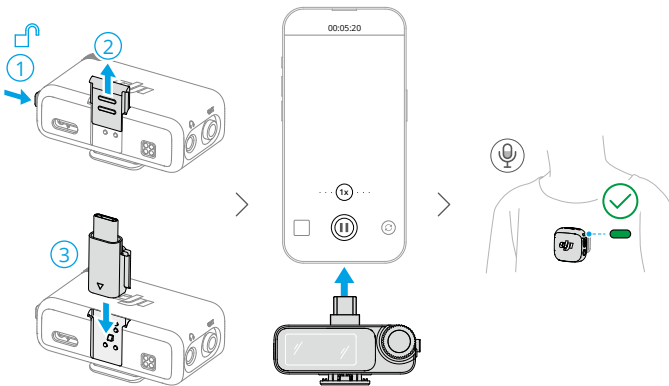

Connecting the Transmitter to Your Phone via Bluetooth

1. When the transmitter is powered on, press and hold the linking button on the transmitter for two seconds until the system status LED blinks blue and green alternately.
2. Enable Bluetooth on the phone and select the name of your microphone among the searched Bluetooth devices to connect. Connection is successful when the status LED on the transmitter is in solid blue.

The transmitter will then function as an audio input device and can be used with third-party recording or live streaming applications.



2.7 Using with a Camera

Installation via Cold Shoe and Audio Cable

Mount the receiver to the camera using the clip and connect the audio cable. The transmitter will then capture audio for the camera.

💡 After installation and connection, refer to Instructions on Recommended Gain for Camera Setup at <https://www.dji.com/mic-3/downloads> for more information.

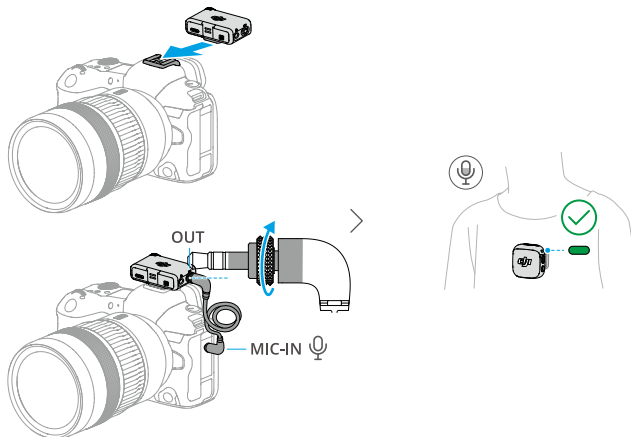

Installation via Camera Adapter

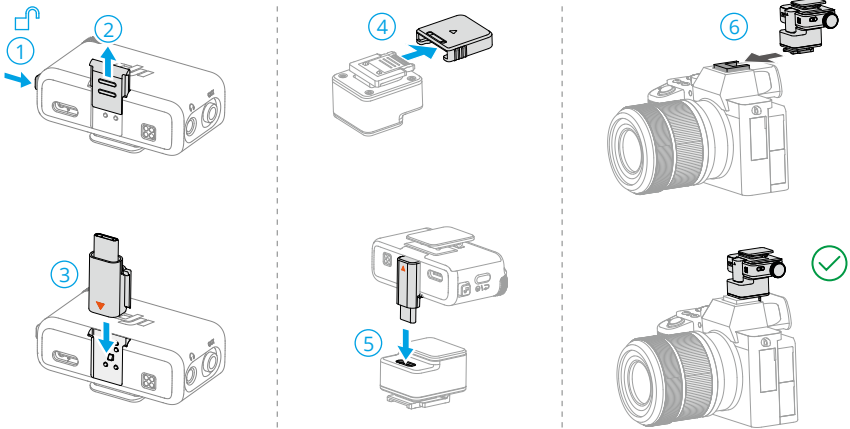

Auto On/Off With Camera

Swipe down on the receiver screen, tap **RX Settings** > **Auto On/Off With Camera**, and enable it. When enabled, the receiver will automatically power on and off with the camera when connected to the camera.

💡 Supported only when the camera is in video mode.

2.8 Using with a Computer

Connect the receiver to the computer using the provided charging cable or adapter and set the audio input options on the computer. The transmitter can then be used as an external microphone.

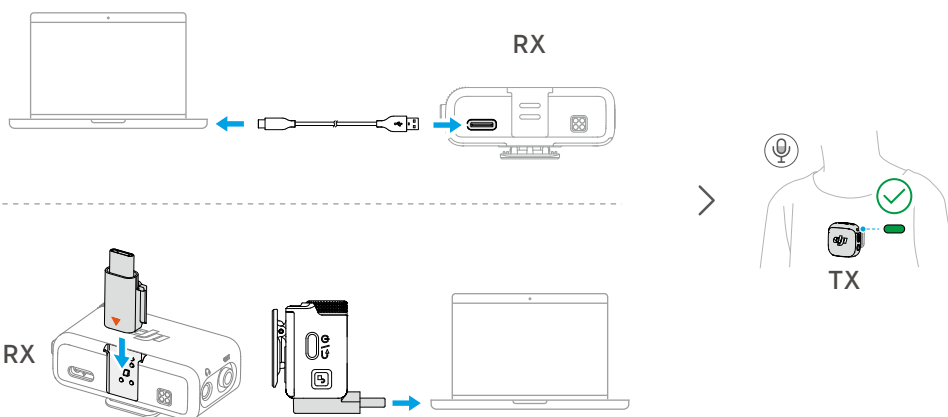

2.9 Transmitter Directly Connected to DJI Filming Devices

The transmitter can connect to DJI filming devices via Bluetooth.

Operation on Osmo Pocket 3 is demonstrated as an example. The interface may vary depending on the device used.

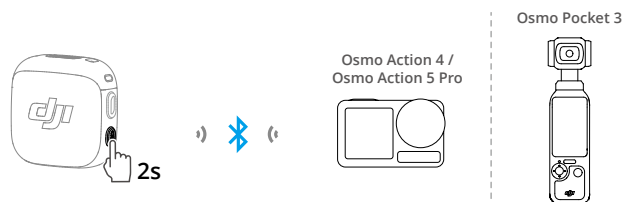

Enter the system settings interface of DJI filming devices. Tap **Wireless Microphone** and add the transmitter. Connection is successful when the status LED on the transmitter is in solid blue.

Press the linking button on the transmitter to start and stop recording on the filming device

Swipe down on the Wireless Microphone interface to configure audio-related parameters for the transmitter. Swipe left on the camera interface to set microphone gain and noise cancellation.

2.10 Charging

Charging with the Charging Case

Place the transmitters and the receiver in the charging case to start charging simultaneously. If the charging case runs out of power, use the provided USB-C cable to charge the case. The transmitter and receiver will automatically power on once removed from the charging case.

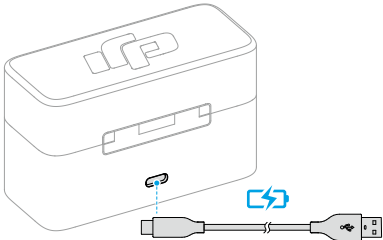

Charging without the Charging Case

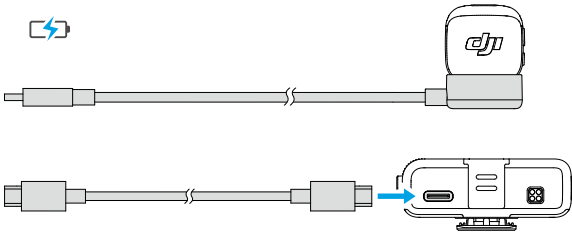

2.11 Storage

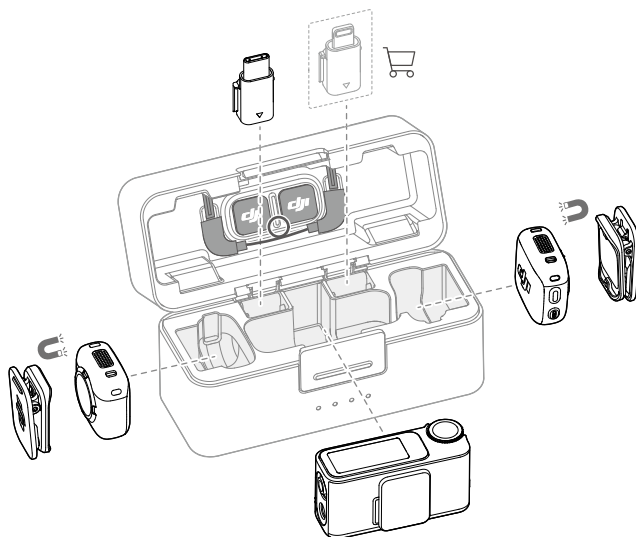

-
- 💡 • The storage slots with magnets also hold clips.
 - Avoid stacking accessories in the charging case to prevent pressure on the receiver screen.
-

3 Firmware Update and Parameter Adjustment

After connecting the microphone to the DJI Mimo app, you can update the firmware or adjust parameter settings using your phone.

3.1 Connecting to the DJI Mimo App

Connecting via the Adapter

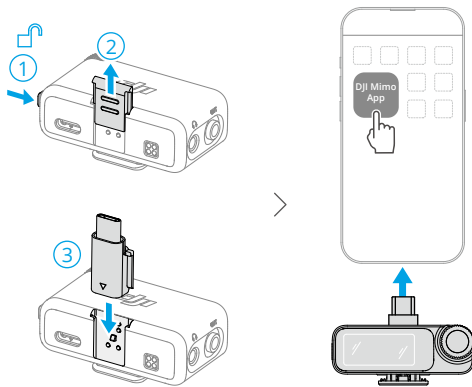

Connecting via Wi-Fi

Connecting the Transmitter

1. When the transmitter is powered on, press and hold the linking button on the transmitter for two seconds until the system status LED blinks blue and green alternately.
2. Open the DJI Mimo app to automatically search for nearby available devices. Tap to connect once the transmitter is discovered.
3. Follow the on-screen instructions, press the linking button of the transmitter to confirm the connectivity.

Connecting the Receiver

1. Swipe down on the receiver home screen and tap **Connect to App**. Search for and connect the receiver in the DJI Mimo app.
2. When a verification code appears on the screen, Tap to complete the connection.

3.2 Adjusting Parameters

In the device settings interface of the DJI Mimo app, you can view connected devices and their battery status or adjust parameters.

3.3 Updating Firmware

When new firmware is available, a notification will appear at the top of the Home page in the app. Tap to update the firmware.

You can also tap *** to view the current firmware version and update the firmware.

If the combo purchased includes a charging case, connect the receiver to the DJI Mimo app via the adapter or Wi-Fi, and then tap the notification to update the firmware. Once the receiver update is complete, place it back in the charging case. The receiver will automatically start the firmware update for the transmitters and charging case.

If you do not have a charging case, connect the transmitter and receiver separately to the DJI Mimo app, and tap the notification to update.

4 Appendix

4.1 Specifications

Visit the following website for specifications.

<https://www.dji.com/mic-3/specs>

4.2 Aftersales Information

Visit <https://www.dji.com/support> to learn more about aftersales service policies, repair services, and support.



Contact
DJI SUPPORT

This content is subject to change without notice.
Download the latest version from



<https://www.dji.com/mic-3/downloads>

If you have any questions about this document, please contact DJI by sending a message to DocSupport@dji.com.

DJI is a trademark of DJI.
Copyright © 2025 DJI All Rights Reserved.